



CE65H600TOEI

CoreGaN 650V GaN HEMT

Description

The CE65H600TOEI Series 650V, 600mΩ gallium nitride (GaN) FETs are normally-off devices.

Coreenergy GaN FETs offer better efficiency through lower gate charge, faster switching speeds, and lower dynamic on-resistance, delivering significant advantages over traditional silicon (Si) devices.

Coreenergy is a leading-edge wide band gap supplier with world-class innovation .

Application

- Adapter
- Renewable energy
- Telecom and data-com
- Servo motors
- Industrial
- Automotive

General Features

Easy to drive—compatible with standard gate drivers
 Low conduction and switching losses
 RoHS compliant and Halogen-free

Benefits

Increased efficiency through fast switching
 Increased power density
 Reduced system size and weight

Ordering Information

Part Number	Package	Package Configuration
CE65H600TOEI	TO252	Source

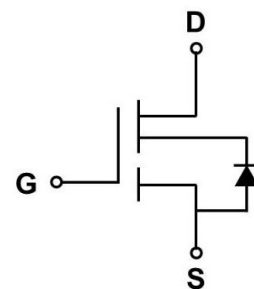
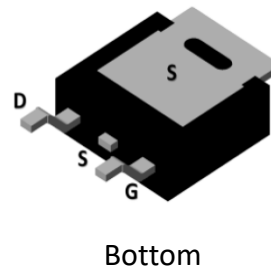
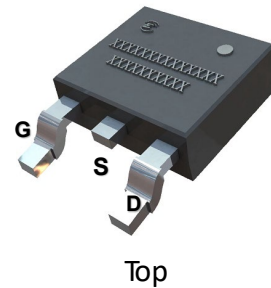

Circuit Symbol

Features

BV_{DSS}	$R_{DS(on)}$	I_{DS}	Q_G
650V	600mΩ	5A	8nC



Absolute Maximum Ratings

$T_c=25^\circ\text{C}$ unless otherwise stated

Symbol	Parameter	Limit value	Unit	
V_{DSS}	Drain to source voltage ($T_J = -55^\circ\text{C}$ to 150°C)	650		
$V_{(TR)DSS}$	Drain to source voltage-transient ^a	800	V	
V_{GSS}	Gate to source voltage	-20~+20		
I_D	Continuous drain current @ $T_c=25^\circ\text{C}$ ^b	5	A	
	Continuous drain current @ $T_c=125^\circ\text{C}$ ^b	2.4		
I_{DM}	Pulse drain current (pulse width: 10 μs)	8	A	
P_D	Maximum power dissipation @ $T_c=25^\circ\text{C}$	41	W	
T_c	Operating temperature	Case	-55~150	$^\circ\text{C}$
T_J		Junction	-55~150	$^\circ\text{C}$
T_S	Storage temperature	-55~150	$^\circ\text{C}$	

a. In off-state, spike duty cycle $D < 0.01$, spike duration $< 1\mu\text{s}$

b. For increased stability at high current operation



Thermal Resistance

Symbol	Parameter	Limit value	Unit
$R_{\theta JC}$	Junction-to-case	3	°C /W



Electrical Parameters

$T_J=25^\circ\text{C}$ unless otherwise stated

Symbol	Parameter	Min	Typ	Max	Unit	Test Conditions
Forward Device Characteristics						
$V_{(BL)DSS}$	Drain-source voltage	650	-	-	V	$V_{GS}=0\text{V}$
$V_{GS(th)}$	Gate threshold voltage	3.3	3.9	4.5	V	$V_{DS}=1\text{V}, I_{DS}=1\text{mA}$
$\Delta V_{GS(th)}/T_J$	Gate threshold voltage temperature coefficient	-	-7	-	mV/ $^\circ\text{C}$	
$R_{DS(on)}$	Drain-source on-Resistance	-	600	720	m Ω	$V_{GS}=10\text{V}, I_D=1\text{A}, T_J=25^\circ\text{C}$
		-	1260	-		$V_{GS}=10\text{V}, I_D=1\text{A}, T_J=150^\circ\text{C}$
I_{DSS}	Drain-to-source leakage current	-	1	10	μA	$V_{DS}=650\text{V}, V_{GS}=0\text{V}, T_J=25^\circ\text{C}$
		-	5	100		$V_{DS}=650\text{V}, V_{GS}=0\text{V}, T_J=150^\circ\text{C}$
I_{GSS}	Gate-to-source forward leakage current	-	-	± 100	nA	$V_{GS}=\pm 20\text{V}$
C_{ISS}	Input capacitance	-	331	-	pF	$V_{GS}=0\text{V}, V_{DS}=400\text{V}, f=1\text{MHz}$
C_{OSS}	Output capacitance	-	11	-		
C_{RSS}	Reverse capacitance	-	1.2	-		
Q_G	Total gate charge	-	8	-	nC	$V_{DS}=400\text{V}, V_{GS}=0\text{V to }10\text{V}, I_D=1\text{A}$
Q_{GS}	Gate-source charge	-	1.7	-		
Q_{GD}	Gate-drain charge	-	4	-		
Q_{OSS}	Output charge	-	14	-	nC	$V_{GS}=0\text{V}, V_{DS}=0\text{V to }400\text{V}, f=1\text{MHz}$
$t_{D(on)}$	Turn-on delay	-	3.2	-	ns	$V_{DS}=400\text{V}, V_{GS}=0\text{V to }10\text{V}, I_D=2.1\text{A},$ $R_{G-on(ext)}=6.8\Omega, R_{G-off(ext)}=2.2\Omega,$ $L=250\mu\text{H}$
t_R	Rise time	-	5.5	-		
$t_{D(off)}$	Turn-off delay	-	7.4	-		
t_F	Fall time	-	27	-		



Electrical Parameters

$T_j=25^\circ\text{C}$ unless otherwise stated

Symbol	Parameter	Min	Typ	Max	Unit	Test Conditions
Reverse Device Characteristics						
V_{SD}	Source-Drain reverse voltage	-	2.3	-	V	$V_{GS}=0\text{V}$, $I_{SD}=2.5\text{A}$
t_{RR}	Reverse recovery time	-	14	-	ns	$I_F=2.5\text{A}$, $V_{DD}=400\text{V}$, $dI_F/dt=165\text{A}/\mu\text{s}$
Q_{RR}	Reverse recovery charge	-	6.5	-	nC	



Typical Characteristics

$T_j=25^\circ\text{C}$ unless otherwise stated

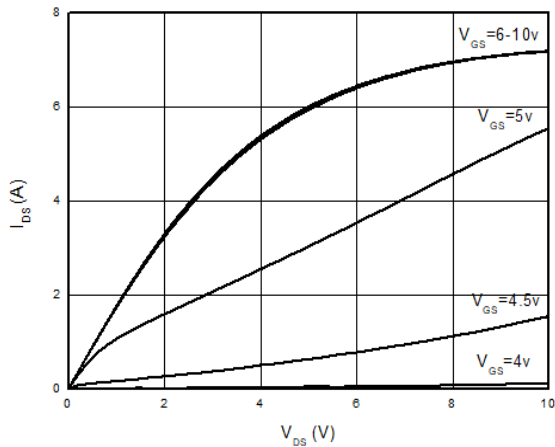

Figure 1. Typical Output Characteristics $T_j=25^\circ\text{C}$

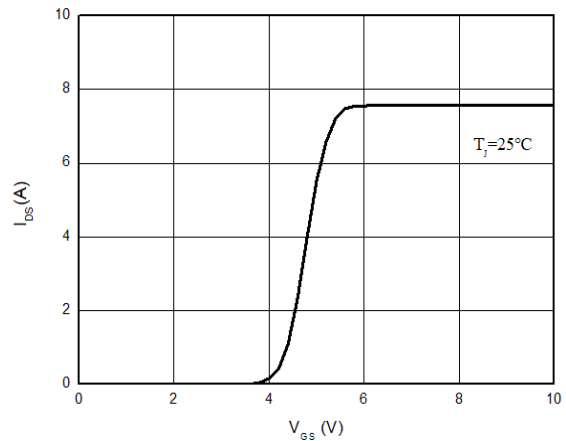

Figure 2. Typical Transfer Characteristics ($V_{DS}=10V$)

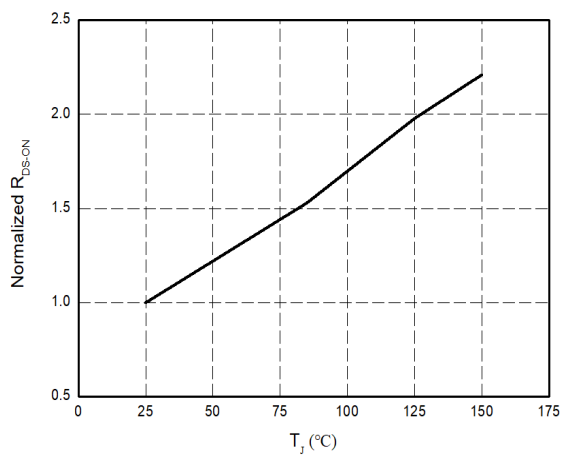

Figure 3. Normalized On-resistance

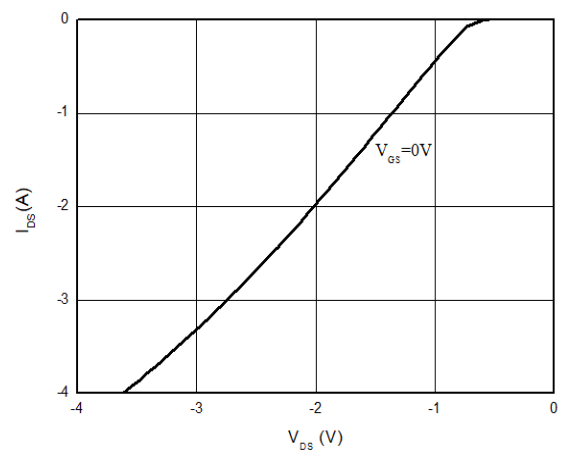

Figure 4. Channel Reverse Characteristics $T_j=25^\circ\text{C}$



Typical Characteristics

$T_j = 25^\circ\text{C}$ unless otherwise stated

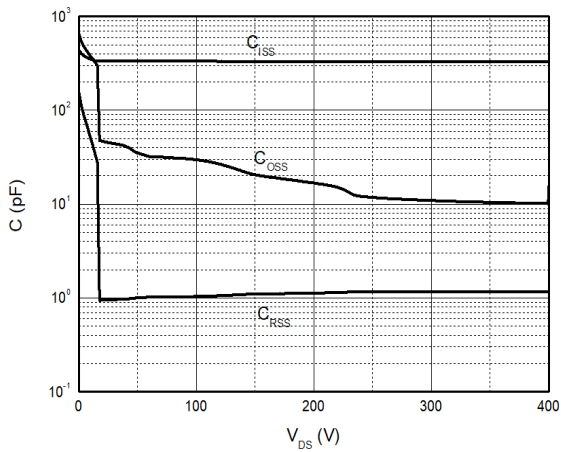

Figure 5. Typical Capacitance (f=1MHz)

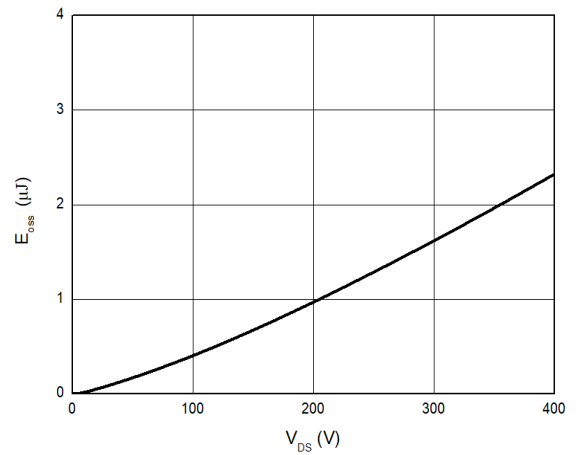

Figure 6. Typical C_{OSS} Stored Energy

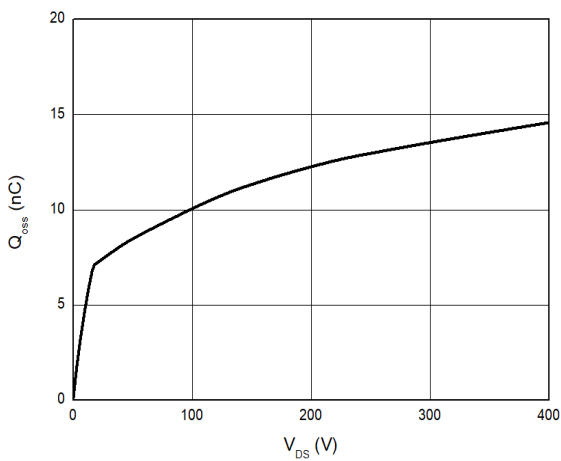

Figure 7. Typical Q_{OSS}

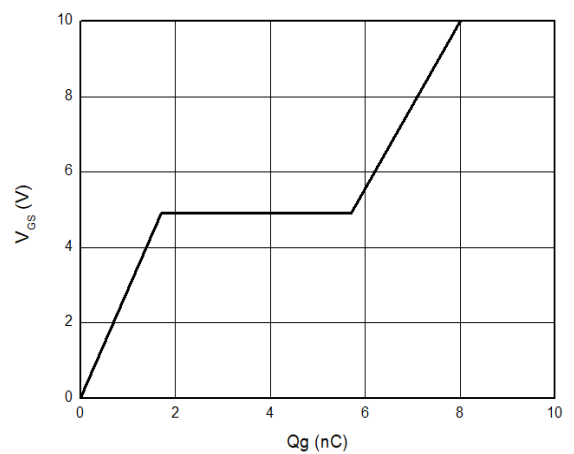

Figure 8. Typical Gate Charge ($V_{DS}=400\text{V}$, $I_D=1\text{A}$)



Typical Characteristics

$T_j=25^\circ\text{C}$ unless otherwise stated

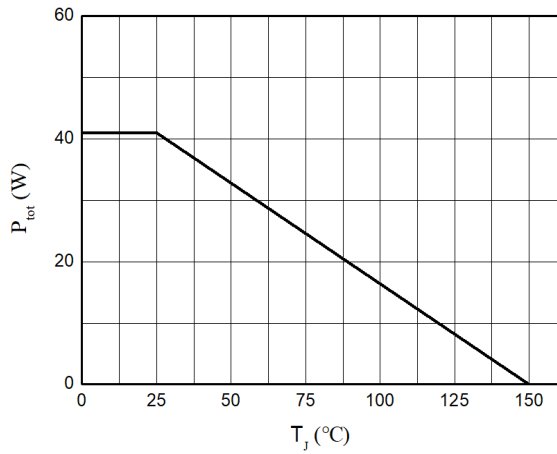

Figure 8. Power Dissipation

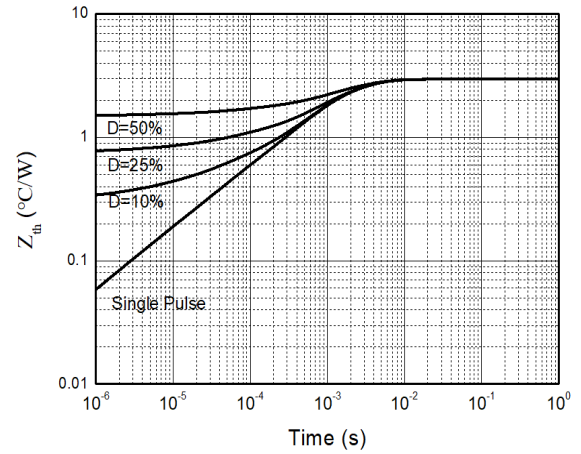

Figure 9. Transient Thermal Resistance

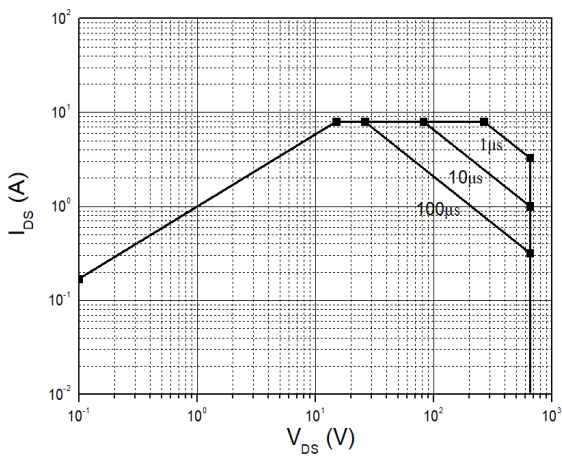

Figure 10. Safe Operating Area $T_c=25^\circ\text{C}$

Typical Characteristics

$T_j=25^\circ\text{C}$ unless otherwise stated

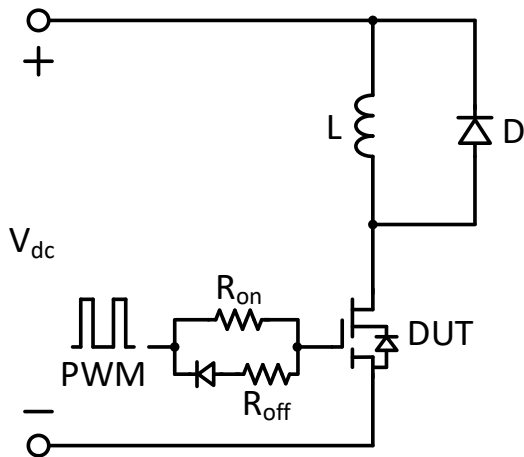

Figure 11. Switching times with inductive load

$V_{DS}=400\text{V}$, $V_{GS}=0\text{V}$ to 10V , $I_D=2.1\text{A}$,

$R_{G-on(ext)}=6.8\Omega$, $R_{G-off(ext)}=2.2\Omega$, $L=250\mu\text{H}$

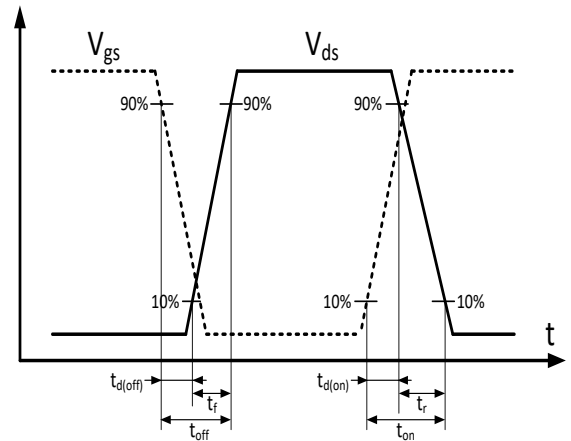
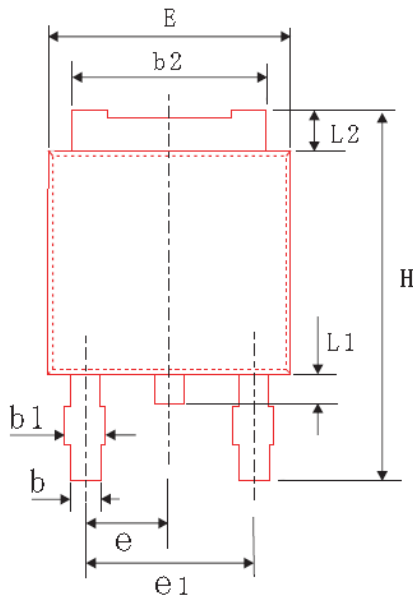

Figure 12. Switching times with waveform

PACKAGE DIMENSIONS

TO252-2L



TOP VIEW

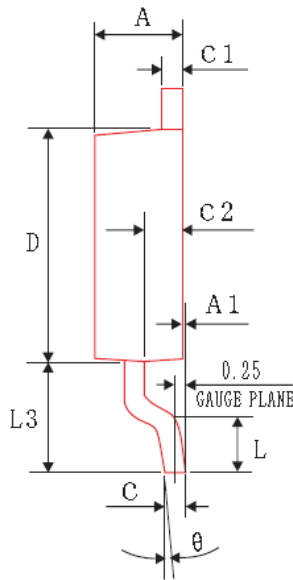

SIDE VIEW

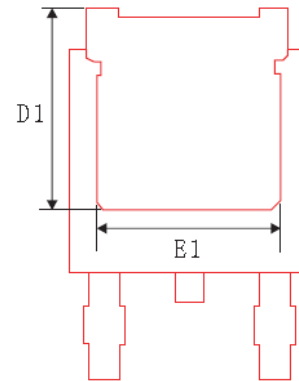

BOTTOM VIEW

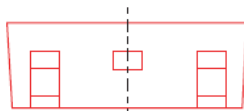

SIDE VIEW

COMMON DIMENSIONS
(UNITS OF MEASURE-mm)

SYMBOL	MIN	NOM	MAX
A	2.20	2.30	2.40
A1	0.00	0.05	0.10
b	0.762	0.812	0.862
b1	---	---	1.10
b2	5.23	5.33	5.43
c	0.458	0.508	0.558
C1	0.458	0.508	0.558
C2	0.80	1.00	1.20
D	6.00	6.10	6.20
D1	5.25	5.45	5.65
H	10.00	10.10	10.20
E	6.50	6.60	6.70
E1	4.75	4.85	4.95
e1	4.37	4.57	4.77
L	---	---	1.45
L1	0.60	0.75	0.90
L2	0.90	1.10	1.30
L3	2.80	3.00	3.20
θ	0°	4°	8°
e	2.285 BSC		



Revision history

Major changes since the last revision

Revision	Date	Description of changes
1.0	2022-02-28	Initial release
2.0	2023-10-30	Enrich dynamic specification curves
3.0	2023-12-25	Update dynamic parameters